

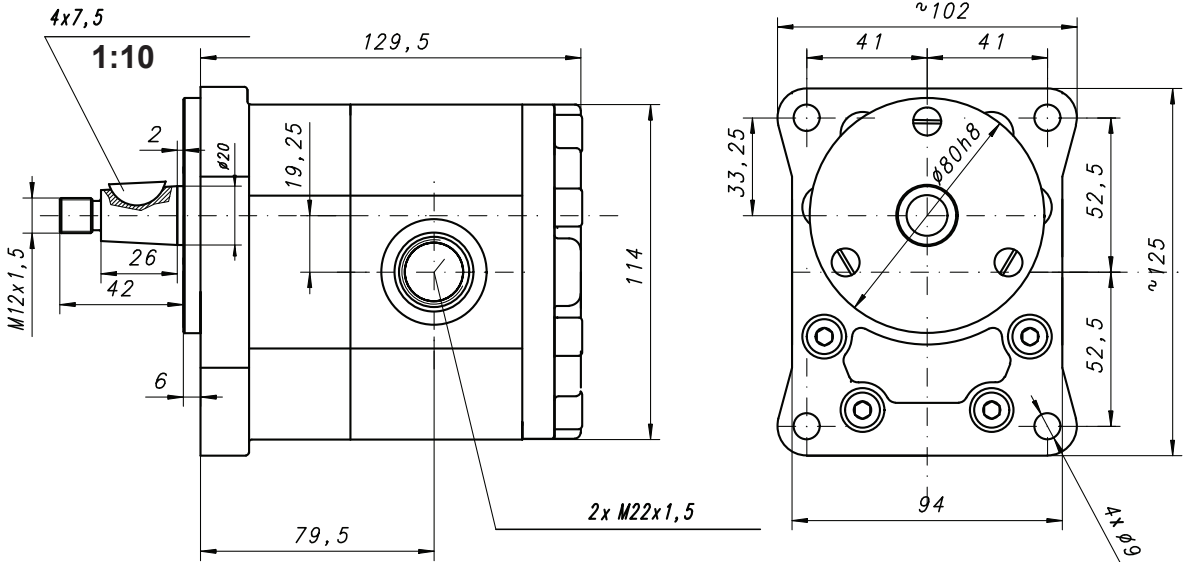

PZ2-KP-16

Pompa hydrauliczna
 Hydraulic pump
 Zahnradpumpe



Informacje techniczne / Technical information / Technische Angaben			
Ciśnienie / Pressure / Druck	MPa	bar	psi
Nominalne / Nominal / Nominal	16	160	2320
Maksymalne chwilowe / Intermittent/ Intermittierende	20	200	2900
Obroty / Revolutions / Drehzahl	Min [min ⁻¹] 750	Max [min ⁻¹] 3000	
Objętość geometryczna / Volumetrical efficiency/ Fordervolumen	12,2 [cm ³ /U]		
Kierunek obrotów /Revolutions / Drehrichtung	prawy lub lewy / right or left / rechts oder links		
Przepływ teoretyczny / theoretical flow / theoretisch Flussrate: n=1600 U/min, η _{VT} =100%	Q _T = 19,52 l/min		
Waga / Weight / Gewicht	4,6 kg		